

90

202

101

model: modular sofa system **CUBAN**  
position: **3-seater + armchair + ottoman**

101

90

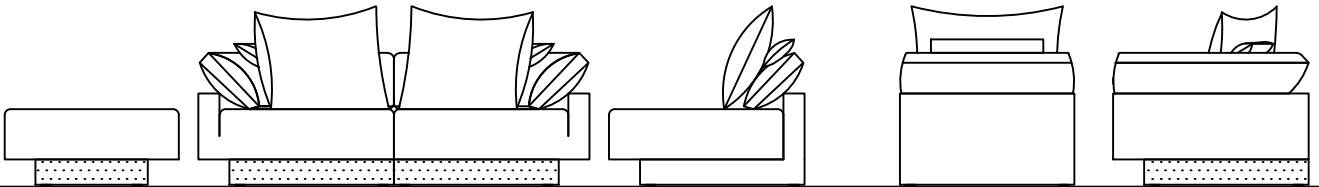
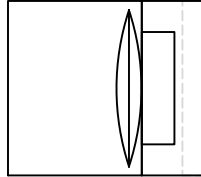
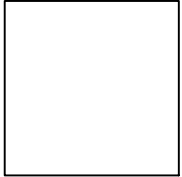
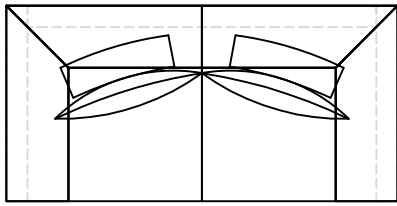

202

model: modular sofa system **CUBAN**  
position: **daybad**

191

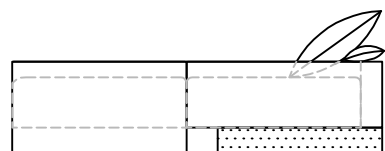
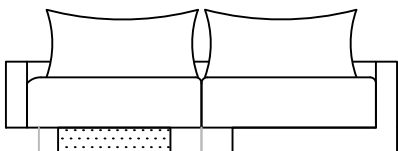
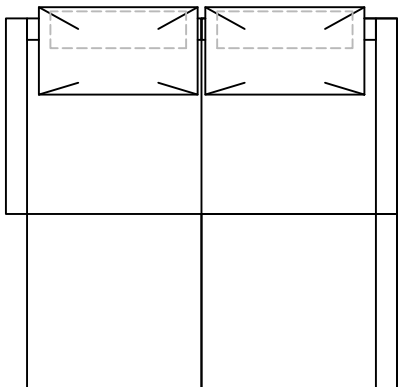

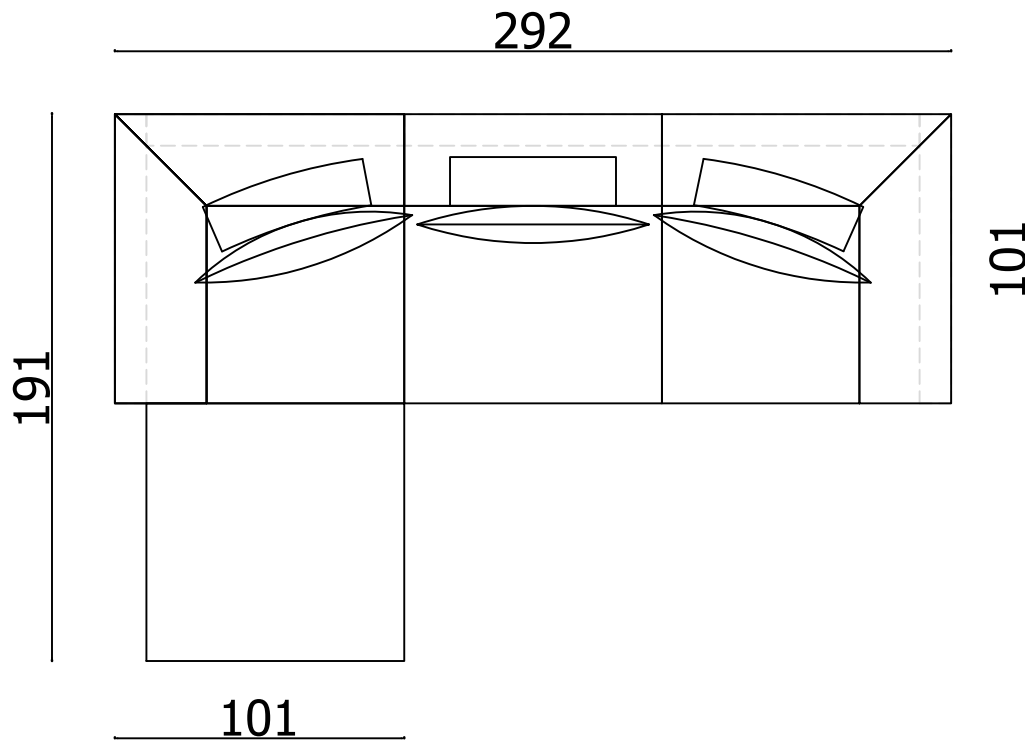

model: modular sofa system **CUBAN**  
position: **corner sofa**  
manufacturer: FEYDOM furniture doo  
designer: Filimena Rdaonjanin

